

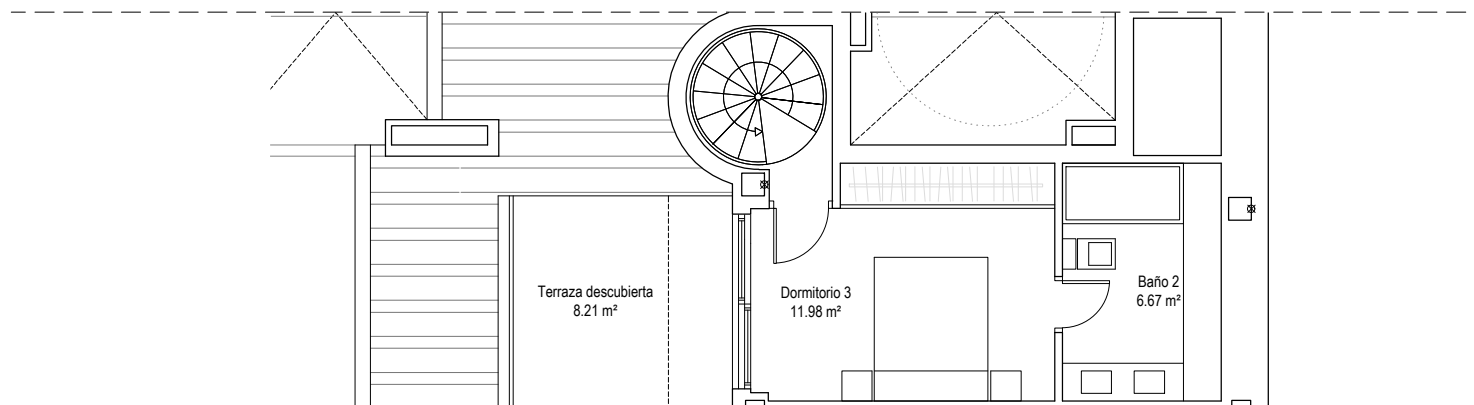

MED HILLS  
FUENGIROLA

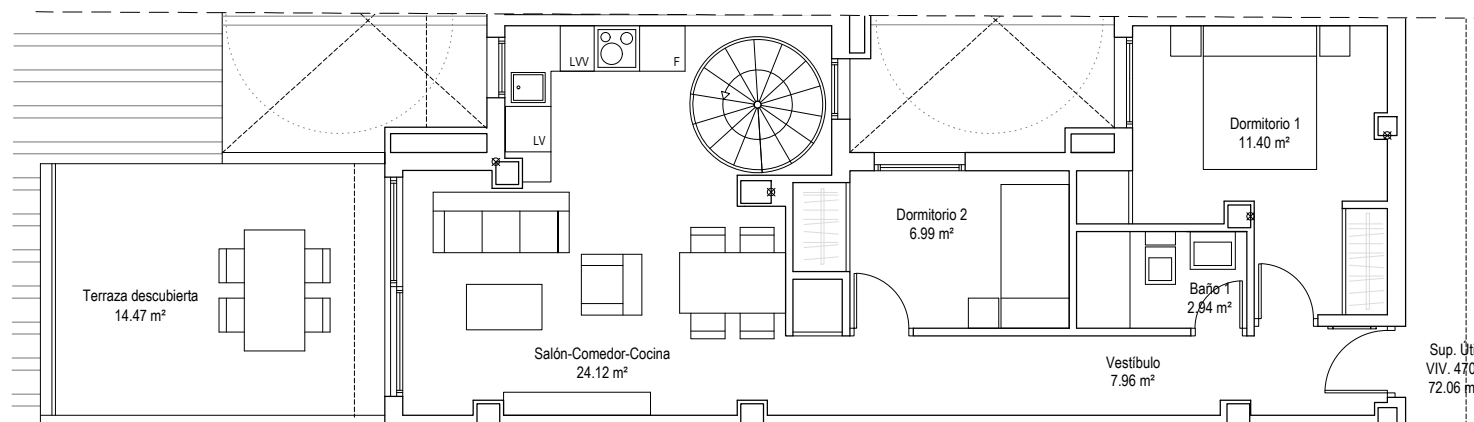

PLANTA SUPERIOR



PLANTA INFERIOR

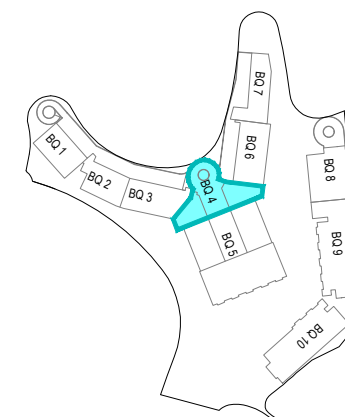

ESCALA GRÁFICA



### BLOQUE 4 - VIVIENDA 4703

#### SUPERFICIES APROXIMADAS

Superficie útil interior:	72.06 m <sup>2</sup>
Superficie útil exterior:	22.68 m <sup>2</sup>
Superficie construida (incluye p.p. zonas comunes):	144.35 m <sup>2</sup>

#### DECRETO 218/2005

Superficie útil:	79.27 m <sup>2</sup>
Superficie construida:	126.64 m <sup>2</sup>

\* Todas las superficies incluidas en el plano son útiles.

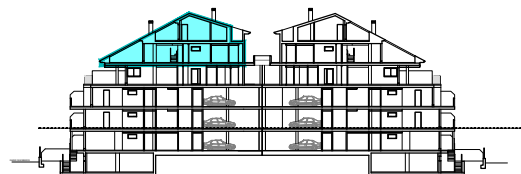



MED HILLS  
FUENGIROLA

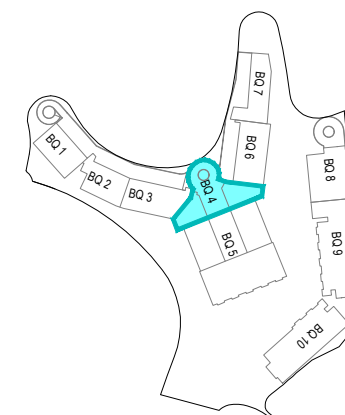
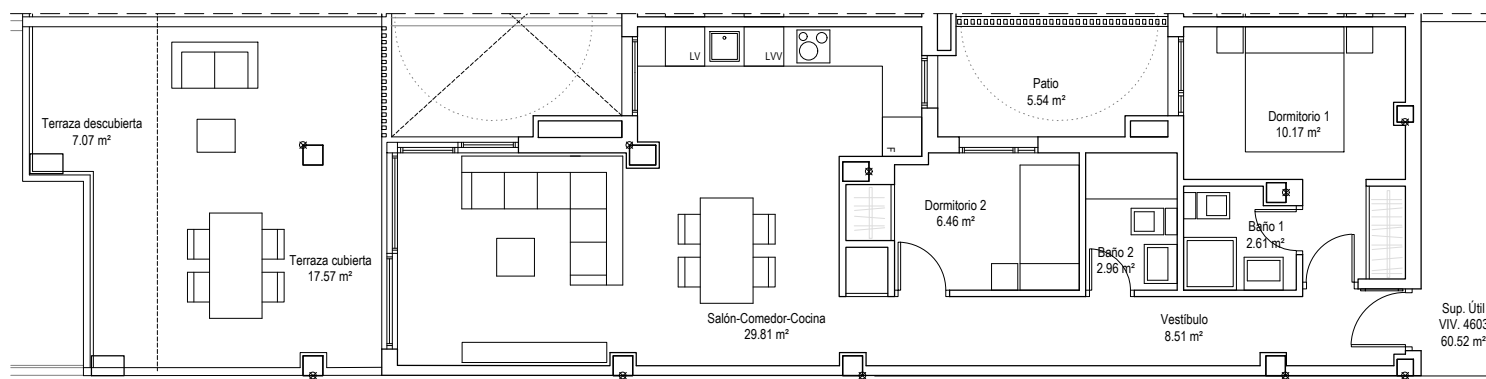

### BLOQUE 4 - VIVIENDA 4603

#### SUPERFICIES APROXIMADAS

Superficie útil interior:	60.52 m <sup>2</sup>
Superficie útil exterior:	30.18 m <sup>2</sup>
Superficie construida (incluye p.p. zonas comunes):	123.75 m <sup>2</sup>

#### DECRETO 218/2005

Superficie útil:	66.57 m <sup>2</sup>
Superficie construida:	87.15 m <sup>2</sup>

\* Todas las superficies incluidas en el plano son útiles.

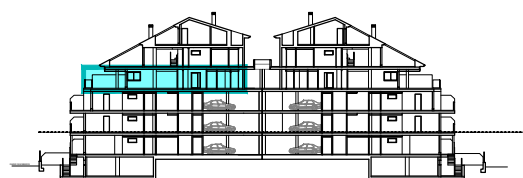
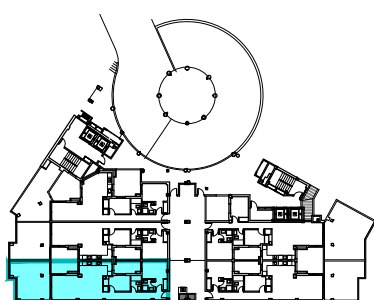



**MED HILLS**  
FUENGIROLA

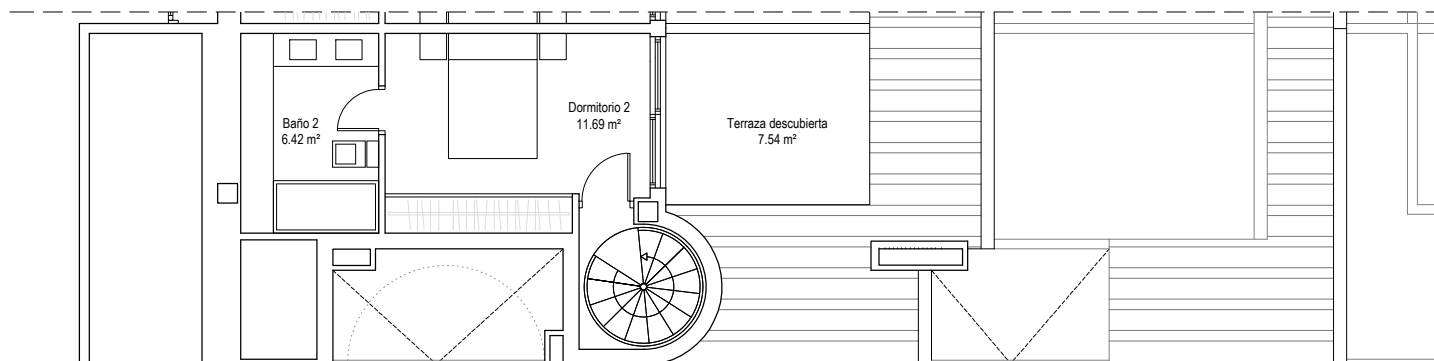

PLANTA SUPERIOR

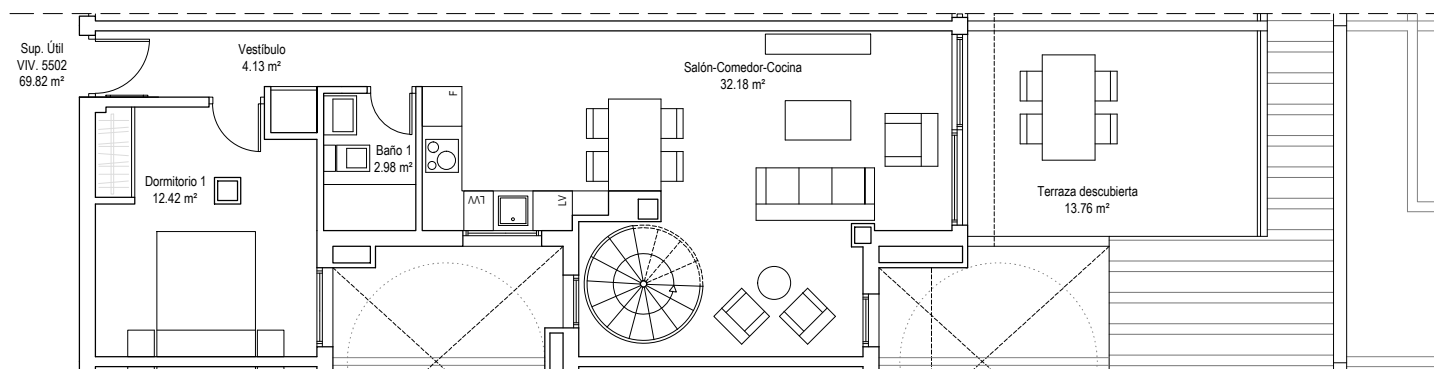

PLANTA INFERIOR

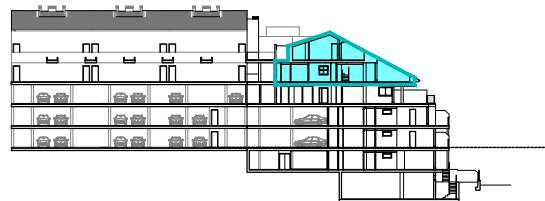
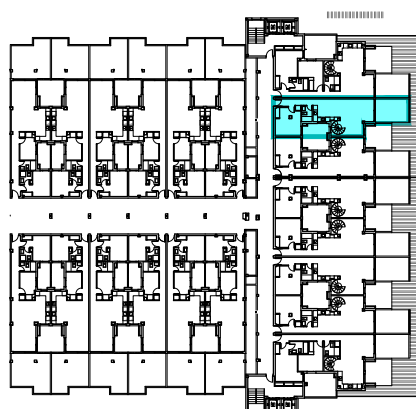
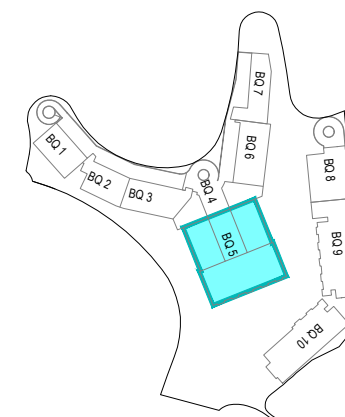

ESCALA GRÁFICA  
0 1 2m

### BLOQUE 5 - VIVIENDA 5502

#### SUPERFICIES APROXIMADAS

Superficie útil interior:	69.82 m <sup>2</sup>
Superficie útil exterior:	21.30 m <sup>2</sup>
Superficie construida (incluye p.p. zonas comunes):	134.82 m <sup>2</sup>

#### DECRETO 218/2005

Superficie útil:	76.80 m <sup>2</sup>
Superficie construida:	119.15 m <sup>2</sup>

\* Todas las superficies incluidas en el plano son útiles.

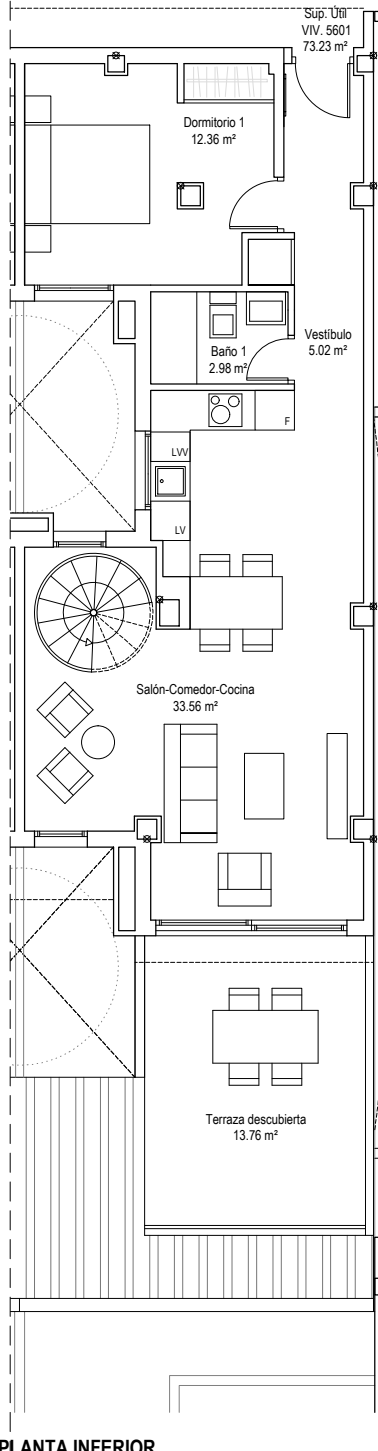

PLANTA INFERIOR

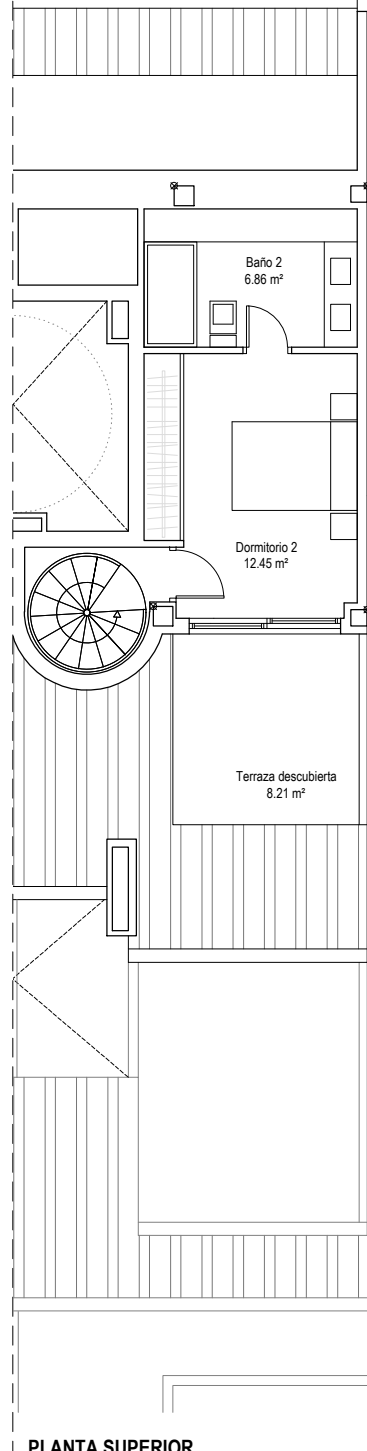

PLANTA SUPERIOR

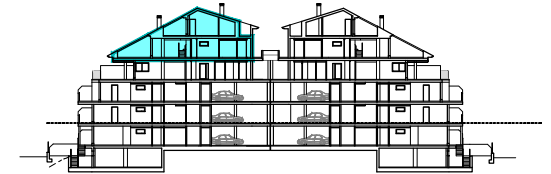
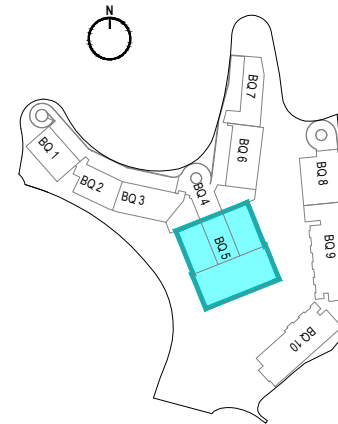
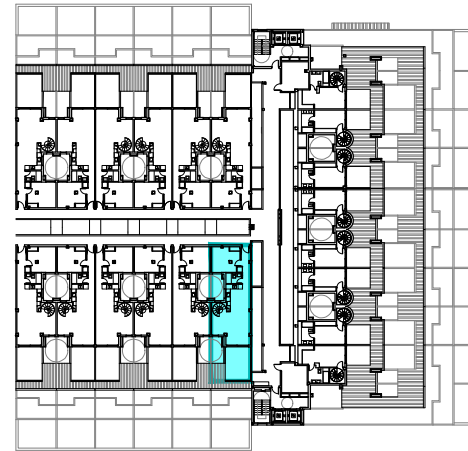

ESCALA GRÁFICA  
0 1 2m

### BLOQUE 5 - VIVIENDA 5601

#### SUPERFICIES APROXIMADAS

Superficie útil interior:	73.23 m <sup>2</sup>
Superficie útil exterior:	21.97 m <sup>2</sup>
Superficie construida (incluye p.p. zonas comunes):	144.22 m <sup>2</sup>

#### DECRETO 218/2005

Superficie útil:	80.55 m <sup>2</sup>
Superficie construida:	126.88 m <sup>2</sup>

\* Todas las superficies incluidas en el plano son útiles.

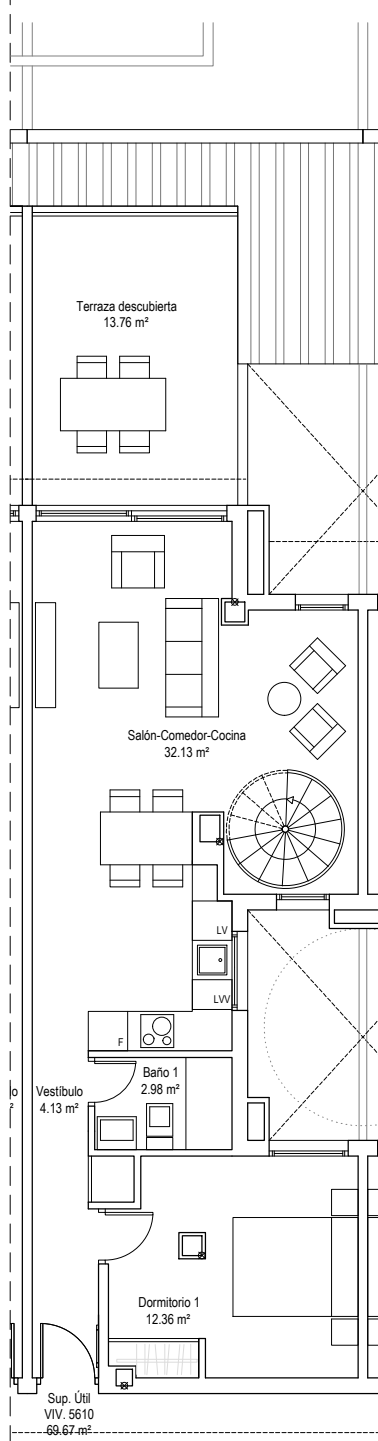

PLANTA INFERIOR

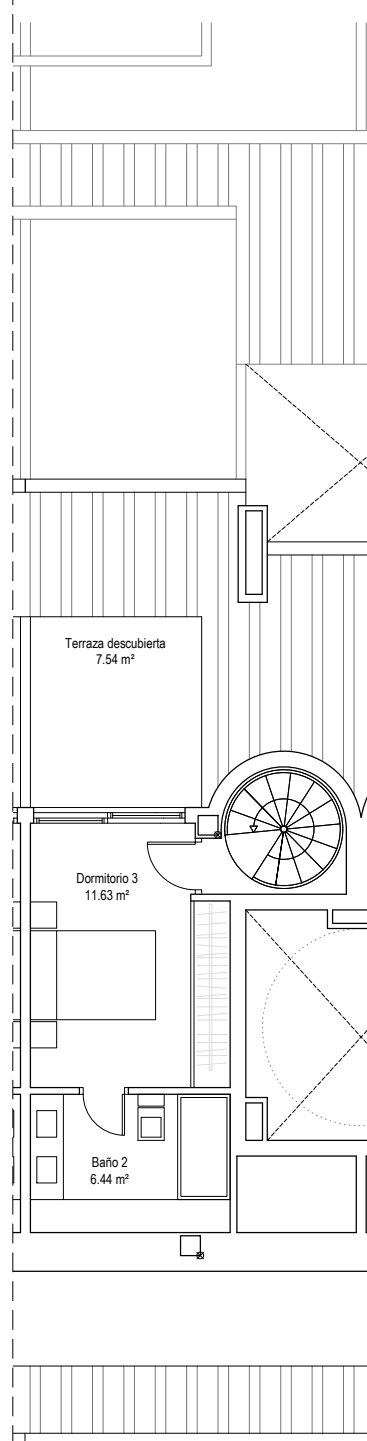

PLANTA SUPERIOR

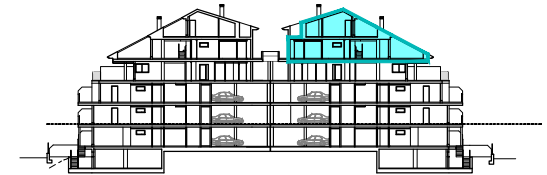
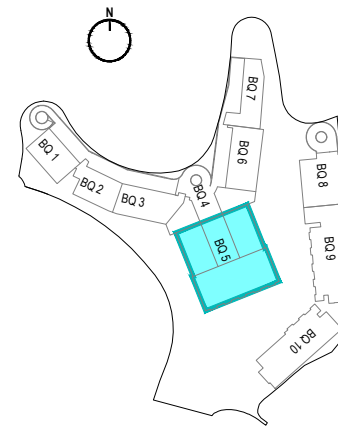
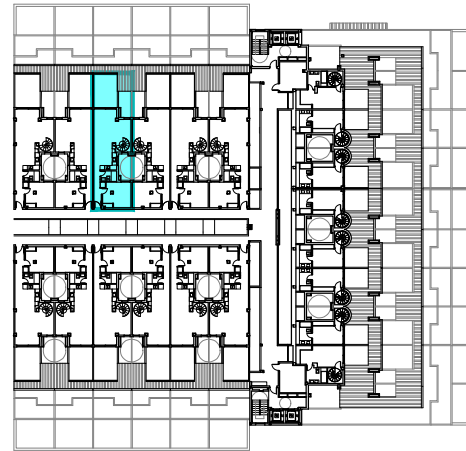

ESCALA GRÁFICA  
0 1 2m

### BLOQUE 5 - VIVIENDA 5610

#### SUPERFICIES APROXIMADAS

Superficie útil interior:	69.67 m <sup>2</sup>
Superficie útil exterior:	21.30 m <sup>2</sup>
Superficie construida (incluye p.p. zonas comunes):	134.81 m <sup>2</sup>

#### DECRETO 218/2005

Superficie útil:	76.64 m <sup>2</sup>
Superficie construida:	119.14 m <sup>2</sup>

\* Todas las superficies incluidas en el plano son útiles.



MED HILLS  
FUENGIROLA

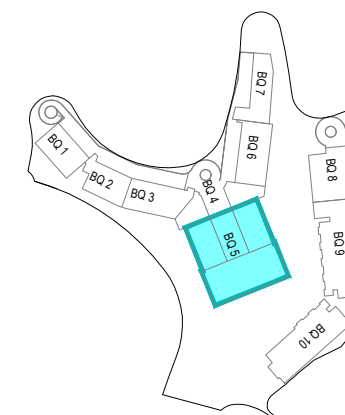
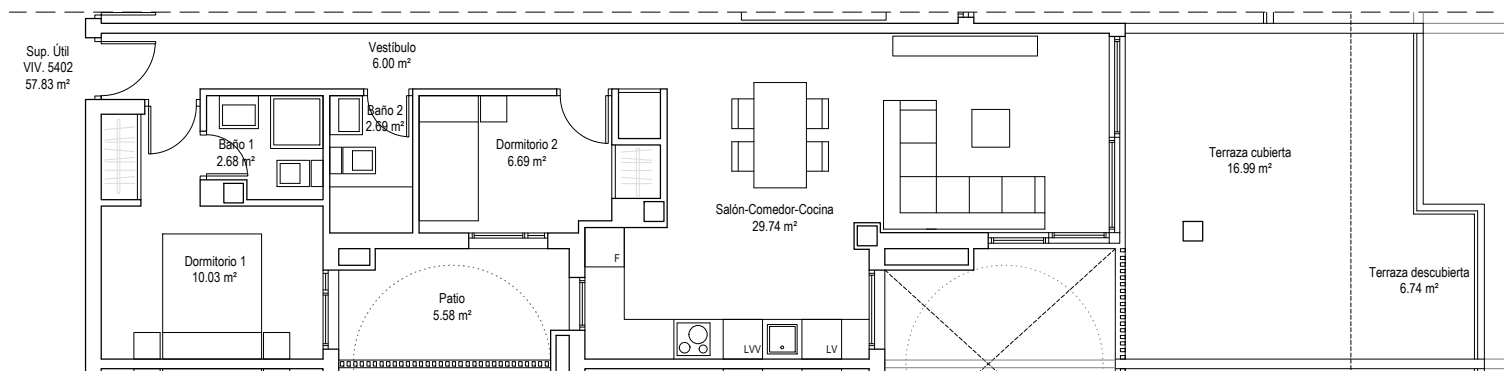

ESCALA GRÁFICA  
0 1 2m

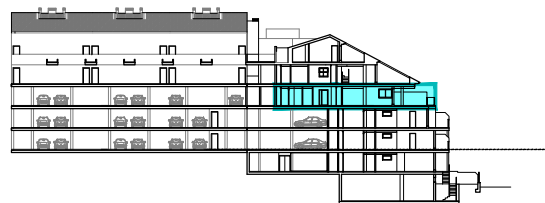
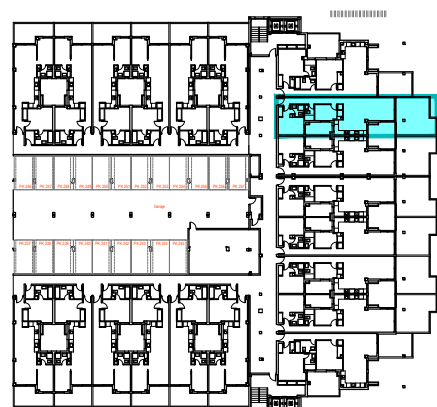

### BLOQUE 5 - VIVIENDA 5402

#### SUPERFICIES APROXIMADAS

Superficie útil interior:	57.83 m <sup>2</sup>
Superficie útil exterior:	29.31 m <sup>2</sup>
Superficie construida (incluye p.p. zonas comunes):	117.33 m <sup>2</sup>

#### DECRETO 218/2005

Superficie útil:	63.61 m <sup>2</sup>
Superficie construida:	82.20 m <sup>2</sup>

\* Todas las superficies incluidas en el plano son útiles.

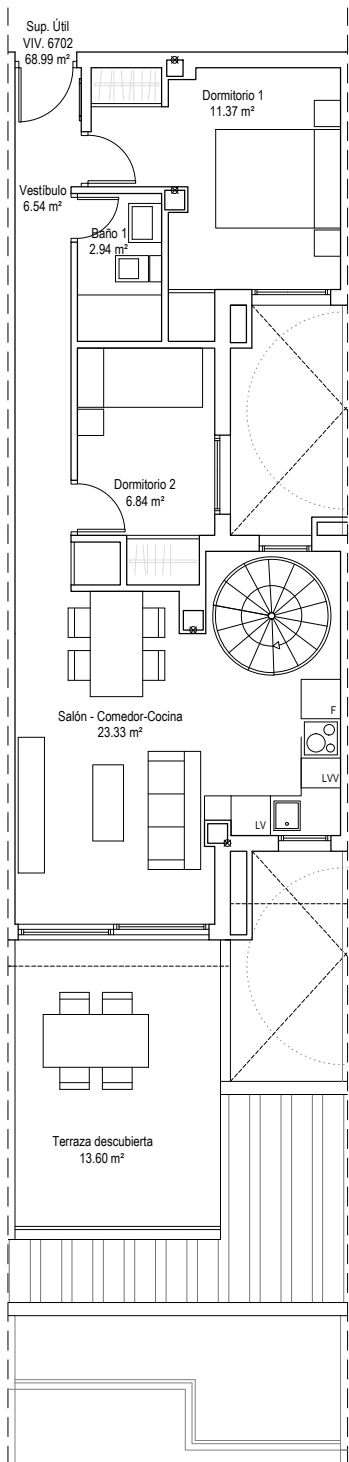

PLANTA INFERIOR

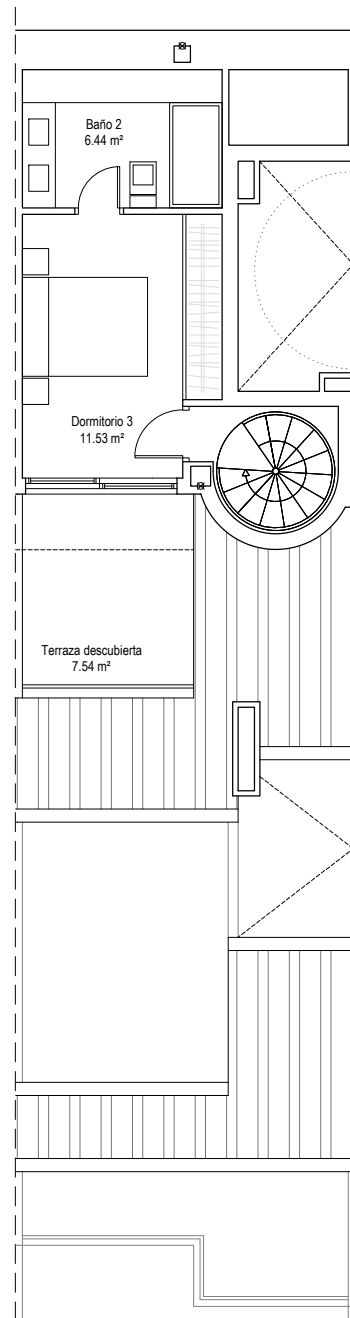

PLANTA SUPERIOR

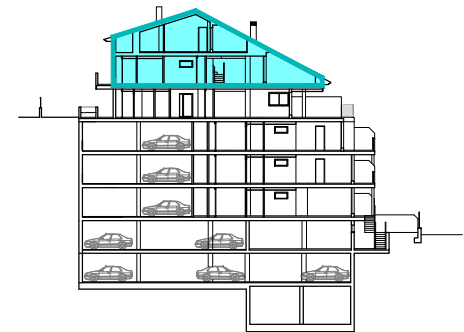
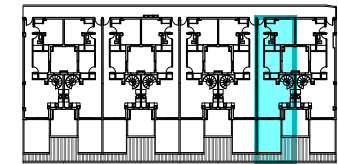
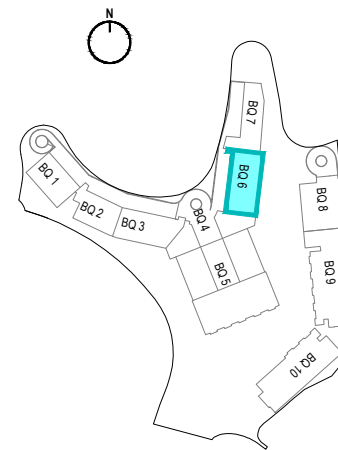

ESCALA GRÁFICA

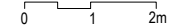

### BLOQUE 6 - VIVIENDA 6702

#### SUPERFICIES APROXIMADAS

Superficie útil interior:	68.99 m <sup>2</sup>
Superficie útil exterior:	21.14 m <sup>2</sup>
Superficie construida (incluye p.p. zonas comunes):	136.04 m <sup>2</sup>

#### DECRETO 218/2005

Superficie útil:	75.86 m <sup>2</sup>
Superficie construida:	120.05 m <sup>2</sup>

\* Todas las superficies incluidas en el plano son útiles.

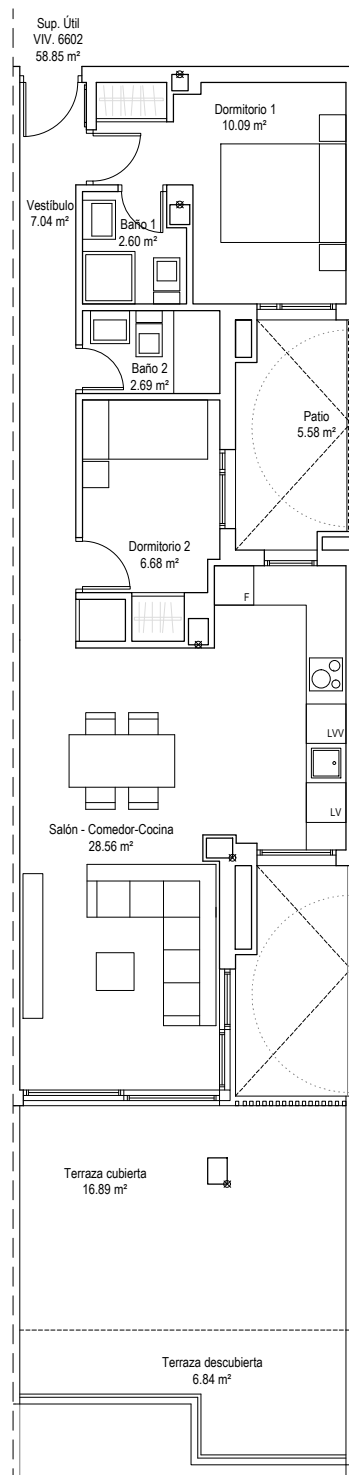

**MED HILLS**  
FUENGIROLA

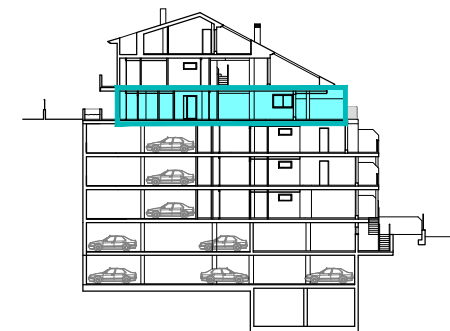
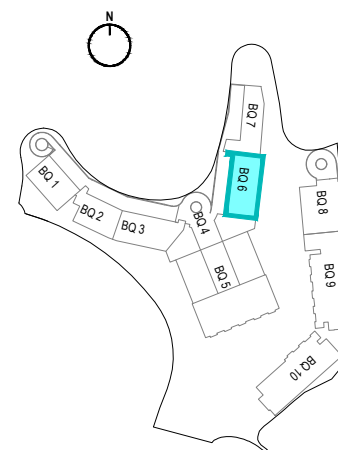
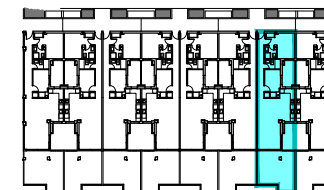

ESCALA GRÁFICA

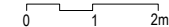

### BLOQUE 6 - VIVIENDA 6602

#### SUPERFICIES APROXIMADAS

Superficie útil interior:	58.85 m <sup>2</sup>
Superficie útil exterior:	29.31 m <sup>2</sup>
Superficie construida (incluye p.p. zonas comunes):	117.95 m <sup>2</sup>

#### DECRETO 218/2005

Superficie útil:	64.74 m <sup>2</sup>
Superficie construida:	83.05 m <sup>2</sup>

\* Todas las superficies incluidas en el plano son útiles.





MED HILLS  
FUENGIROLA

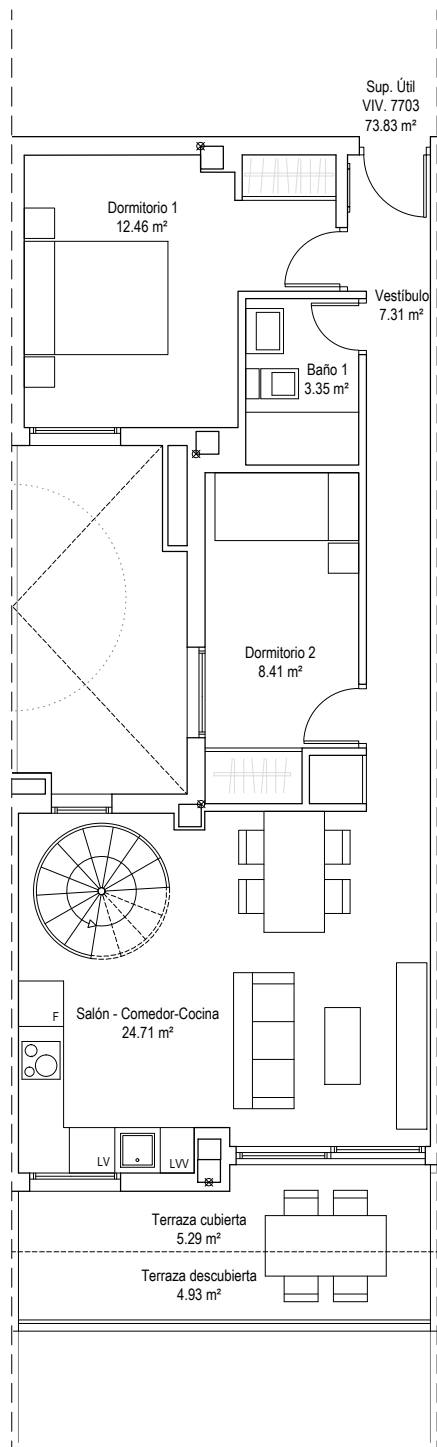

PLANTA INFERIOR

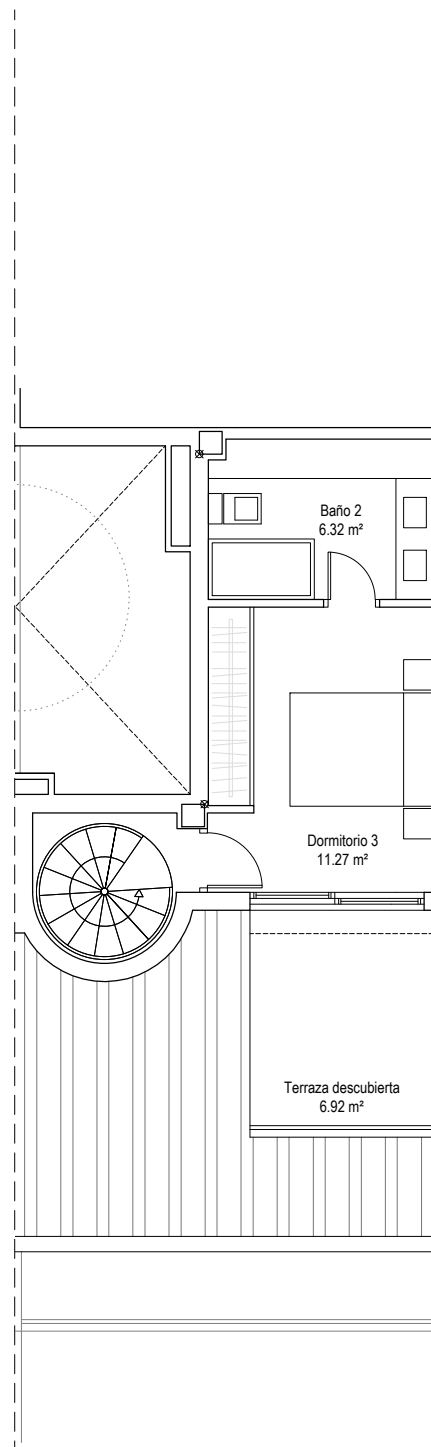

PLANTA SUPERIOR

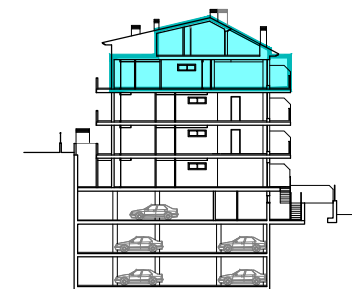
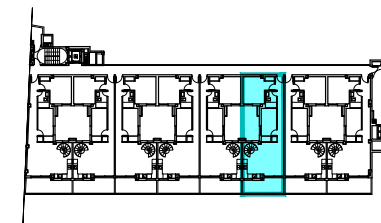
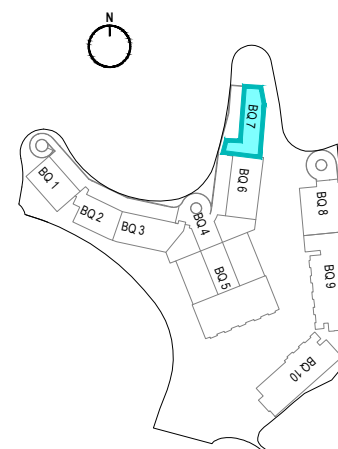

ESCALA GRÁFICA

0 1 2m

### BLOQUE 7 - VIVIENDA 7703

#### SUPERFICIES APROXIMADAS

Superficie útil interior:	73.83 m <sup>2</sup>
Superficie útil exterior:	17.14 m <sup>2</sup>
Superficie construida (incluye p.p. zonas comunes):	149.03 m <sup>2</sup>

#### DECRETO 218/2005

Superficie útil:	81.21 m <sup>2</sup>
Superficie construida:	105.72 m <sup>2</sup>

\* Todas las superficies incluidas en el plano son útiles.